



CONTACT ITALIA REGLETA COMPONENTIBILA DE TRECERE CU CLEMA 35MMP TRANSPARENTA

Gama de produse este formata din trei modele cu un singur pol MC06, MC16, MC35 care permit introducerea firelor cu sec \times iuni max respectiv de 6 mm², 16 mm², 35 mm².

Modele cu aceeasi sectiune pot fi asamblate in diferite configuratii de la doua pana la cinci poli. In combina \times ie cu trei si cinci poli rezultatul este o structura piramidala care optimizeaza utilizarea spatiului, in special in aplica \times iile de imbinari de rasini si gel. De asemenea, este posibil s \times se creeze modele cu diferite sec \times iuni, practic regletele se pot amesteca intre ele.



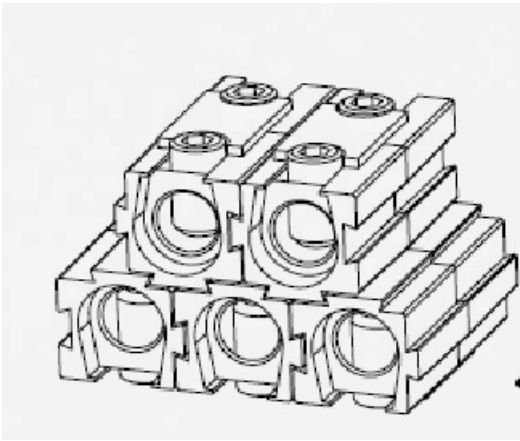

Specificatii tehnice :

- temperatura de functionare -20 +90 grade celsius
- tensiune nominala 500 V
- curent nominal: 24 A pentru MC06, 41A pentru MC16, 76 A pentru MC35

Dimensiunie

MC06

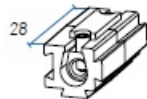
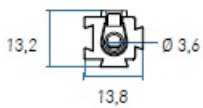

MC16

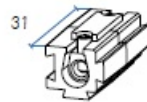
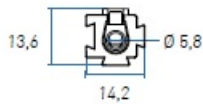

MC35

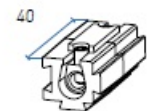
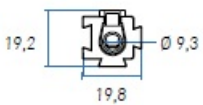

Pret: 25,28 LEI (TVA inclus)

Detalii online: <https://www.materialelectrice.ro/regleta-componibila-de-trecere-cu-clema-35mmp-transparenta>