



SOCOMEC INVERSOR MANUAL DE SURSE,SIRCO M1,4X40A

SIRCO M sunt comutatoare modulare ac?ionate manual cu trei sau patru poli ?i indicarea pozi?iei de comutare.

Ele ofer? comutarea, inversarea de surse sau permutarea a dou? circuite din distribu?ie, la joas? tensiune, ?n sarcin?, precum ?i izolarea de siguran?? a acestora.

Curent: 40A

Nr. poli: 4

Dimensiuni:

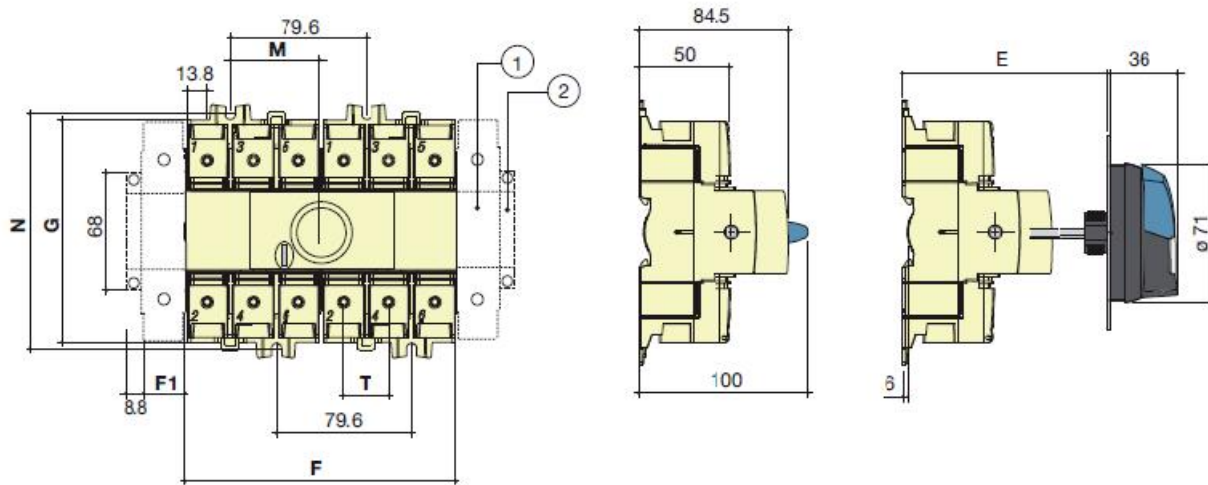

Recomandare pentru montaj in tablou electric.

25 to 125 A

Handle type	Front operation Direction of operation	Door drilling		
S00 type Changeover switches I-0-II and I - I+II - II		IP55 with 2 fixing clips 	IP65 with 4 fixing screws 	With fixing nut

Functii :

- conectarea sau deconectarea circuitelor electrice de joasa tensiune aflate sub sarcina
- separarea circuitelor electrice de la una dintre sursele de alimentare electric , garantand comutare brusca pe sursa secundara
- utilizare ca intrerupator general
- circuit protejat poate resita la curenti de scurtcircuit mari

Caracteristici tehnice :

- tensiune nominala : cel mult 415V ; 50/60HZ
- borna racordare cu surub
- conexiune conductoare rigide sau flexibile
- anduranta electrica 5000 operatii
- anduranta mecanica 10000 operatii
- Montaj pe suprafata -fixare prin suruburi

- material plastic rezistent la UV
- Temperatura mediului ambiant 20-40 grade celsius
- posibilitatea de scoatere a levierului pe panoul frontal
- dimensiuni de gabarit reduce
- indicatie ce sursa de alimentare este folosita
- manerul se comanda separat - cod 22995012

Pret: 352,34 LEI (TVA inclus)

Detalii online: <https://www.materialeelectrice.ro/inversor-manual-de-surse-sirco-m1-4x40a>