



ATM LIGHTING CORP ILUMINAT LED ANTIEXPLOZIE D9000 42X3W

Proiectorul LED d9000 este destinat zonelor industriale cu potential exploziv cum ar fi platformele petroliere, rafinarii, benzinarii etc.

Materiale folosite:

Carcas?: aluminiu turnat

Dispensar: sticla borosilicata

Caracterisitici tehnice :

Tensiune de alimentare 220-240V

Clasa de protec?ie modul: I

Grad de protec?ie: IP66, IP67 CRI: >75

Putere LED 42x3W

Clasa de temperatura: T4

Flux luminos : 10200 lm

Consum de energie: ~135W

Factor de putere: ? 0,95

Durata de via??:> 50.000h L95B10

Temperatura de culoare: 5000K

Temperatura mediului ambiant : de la -20 ° C pân? la + 40 ° C

Conexiune conductor: 3x2.5mmp

Diametru cablu: Ø mm 7-17

Lampi echivalente: MH250 (versiunea cu fascicul restrans)

Dimensiuni:

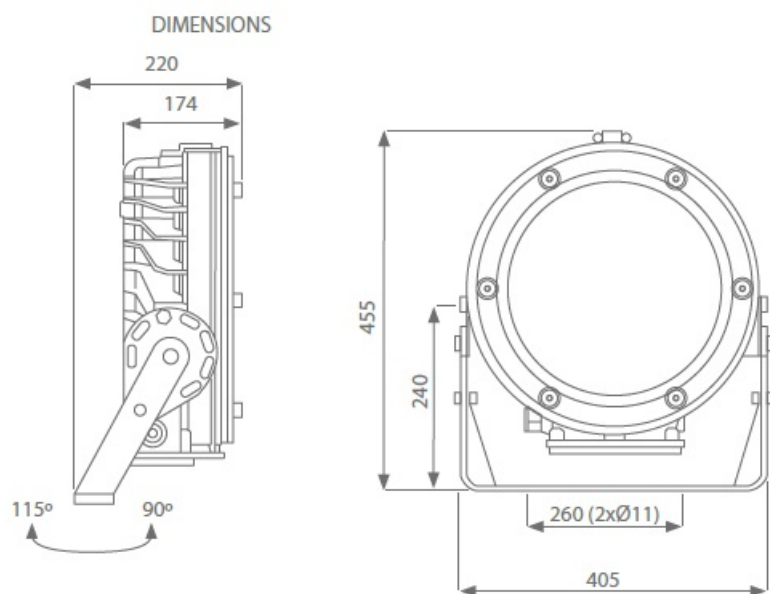

Distributie luminoasa:

PHOTOMETRY

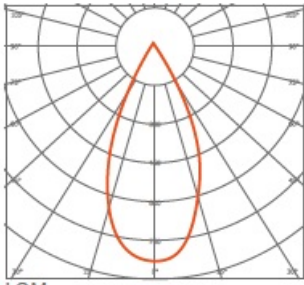

LOM

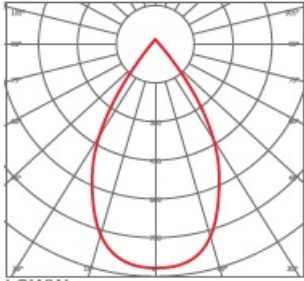

LOWW

Pret: 21.433,57 LEI (TVA inclus)

Detalii online: <https://www.materialelectrice.ro/atm-lighting-corp-iluminat-led-d9000-antiexplozie-42x3w-26683>