

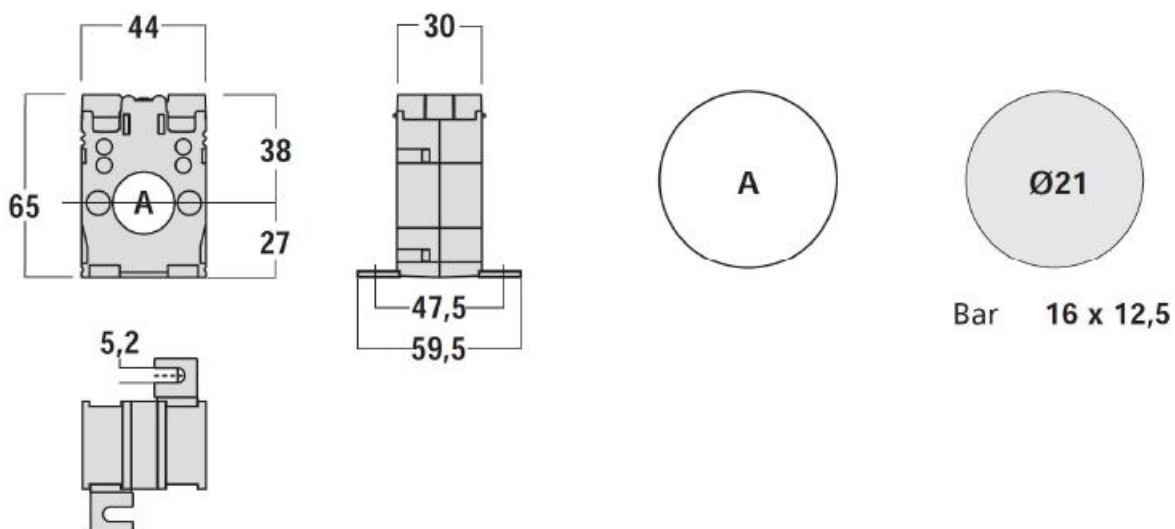

SCHRACK TRANSFORMATOR, REDUCTOR DE CURENT 150/5A, D=21MM



Option: 35mm rail mounting (EN 50022)



Optional se poate fix pe sina omega de 38 sau 44,5

In aceasta grupa de dimensiuni cu diametrul de 21mm, exista reductoare de curent de 5A pana la 250A, care au acuretate si clase diferite conform tabelului de mai jos:

Type:	Clasa acuretate		
	Class 0,5	Class 1	Class 3
40/5A			1VA
50/5A		1,25VA	1,5VA
60/5A		1,25VA	2VA
80/5A		1,5VA	2,5VA
100/5A	2VA	2,5VA	3VA
150/5A	2,5VA	4VA	5VA
200/5A	4VA	5,5VA	6VA
250/5A	5VA	6VA	7VA

Diagrama electrica :

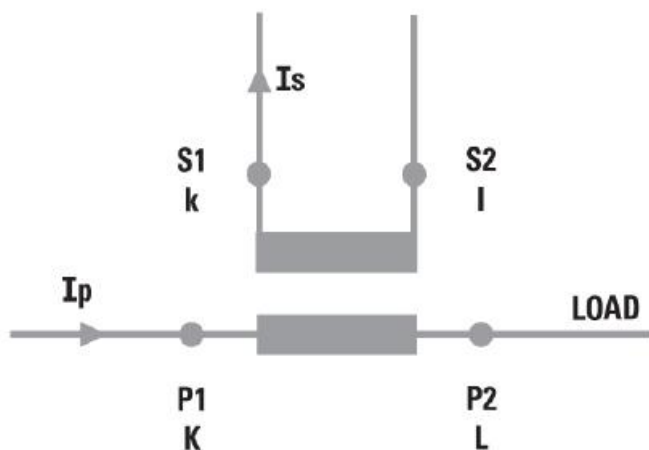

Se utilizeaza in special pentru ampermetre cu [masura indirecta](#), [analizoare de retea](#) etc.

Pret: 86,77 LEI (TVA inclus)

Detalii online: <https://www.materialeelectrice.ro/transformator-reductor-de-curent-150-5a-d-21mm>