

Furnizor: **Sc Trivolt Distribution SRL**  
 Reg. com.: J23/3300/2016  
 CIF: RO36421140  
 Adresa: Strada Apusului nr 3 ( primul  
 sens giratoriu Tehodor Pallady-  
 Autostrada Soarelui), Catelu, Ilfov  
 Banca: BRD  
 IBAN: RO34BRDE441SV13182234410

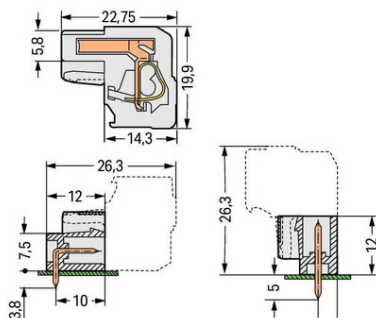

**WAGO 1-CONDUCTOR FEMALE PLUG; ANGLED; 100% PROTECTED  
 AGAINST MISMATING; 2.5 MM<sup>2</sup>; PIN SPACING 5 MM; 11-POLE; 2,50  
 MM<sup>2</sup>; LIGHT GRAY**

Ratings per: IEC/EN 60664-1;  
 Tensiune nominala (III/3): 320; V  
 Tensiune nominala de supratensiune (III/3): 4; kV  
 Tensiune nominala (III/2): 320; V  
 Tensiune nominala de supratensiune (III/2): 4; kV  
 Tensiune nominala (II/2): 630; V  
 Tensiune nominala de supratensiune (II/2): 4; kV  
 Curent nominal: 14; A  
 Legend (ratings): (III / 2)  $\hat{=}$  Overvoltage category III / Pollution degree 2;  
 Tensiune nominala UL (Use Group B): 300; V  
 Curent nominal UL (Use Group B): 15; A  
 Tensiune nominala UL (Use Group D): 300; V  
 Curent nominal UL (Use Group D): 10; A  
 Certificari: UL 1059;  
 Tensiune nominala UL 1977: 600; V  
 Curent nominal UL 1977: 15; A  
 Tensiune nominala CSA (Use Group B): 300; V  
 Curent nominal CSA (Use Group B): 15; A  
 Tensiune nominala CSA (Use Group D): 300; V  
 Curent nominal CSA (Use Group D): 10; A  
 Tehnologie conexiune: CAGE CLAMP®;  
 Tip actionare: Operating tool;  
 Solid conductor: 0.08 ... 2.5 mm<sup>2</sup> / 28 ... 12 AWG;  
 Fine-stranded conductor: 0.08 ... 2.5 mm<sup>2</sup> / 28 ... 12 AWG;  
 Fine-stranded conductor; with insulated ferrule: 0.25 ... 1.5 mm<sup>2</sup>;  
 Fine-stranded conductor; with uninsulated ferrule: 0.25 ... 2.5 mm<sup>2</sup>;  
 Strip length: 8 ... 9 mm / 0.31 ... 0.35 inch;  
 Numar poli: 11;  
 Numar total de conexiuni: 11;  
 Total number of potentials: 11;  
 Numar tipuri de conexiuni: 1;  
 Numar nivele: 1;  
 Conductor entry direction to mating direction: 90; °  
 Distanta intre pini: 5 mm / 0.197 inch;  
 Latime: 57.4 mm / 2.26 inch;  
 Inaltime: 19.9 mm / 0.783 inch;  
 Adancime: 22.75 mm / 0.896 inch;  
 Design: angled;  
 Tip contact (pluggable connector): Conector mama/priza;  
 Connector (connection type): for conductors;  
 Mismatching protection: Yes;  
 Culoare: light gray;  
 Material group: I;  
 Material izolator: Polyamide 66 (PA 66);  
 Flammability class per UL94: V0;  
 Clamping spring material: Chrome nickel spring steel (CrNi);  
 Contact material: Copper alloy;  
 Contact plating: tin-plated;  
 Fire load: 0,338; MJ  
 Greutate: 20,7; g  
 Temperatura lucru: -60 ... +85 °C;  
 Product Group: 3 (Multi Conn. System);  
 Tip ambalare: BOX;  
 Tara de origine: PL;  
 GTIN: 4045454928476;  
 Customs tariff number: 85366990990;  
 Pret: 42,35 lei (TVA inclus)

Detalii online: <https://www.materialelectrice.ro/1-conductor-female-plug-angled-100-protected-against-mismatching-2-5-mm2-pin-spacing-5-mm-11-pole-2-50-mm2-light-gray-149486>