

Furnizor: **Sc Trivolt Distribution SRL**
Reg. com.: J23/3300/2016
CIF: RO36421140
Adresa: Strada Apusului nr 3 (primul
sens giratoriu Tehodor Pallady-
Autostrada Soarelui), Catelu, Ilfov
Banca: BRD
IBAN: RO34BRDE441SV13182234410

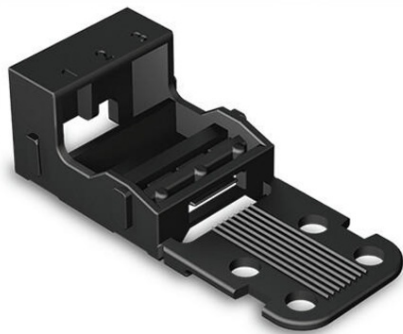

**WAGO MOUNTING CARRIER; FOR 3-CONDUCTOR TERMINAL
BLOCKS; 221 SERIES - 4 MM²; WITH SNAP-IN MOUNTING FOOT
FOR HORIZONTAL MOUNTING; BLACK**

Latime: 23.7 mm / 0.933 inch;
Inaltime: 21.4 mm / 0.843 inch;
Inaltime de la fata: 16.9 mm / 0.665 inch;
Adancime: 52.8 mm / 2.079 inch;
Culoare: black;
Material izolator: Polyamide 66 (PA 66);
Flammability class per UL94: V0;
Greutate: 3,6; g
Tip ambalare: BOX;
Tara de origine: CN;
GTIN: 4055143640916;
Customs tariff number: 39269097900;
Pret: 3,40 lei (TVA inclus)

Detalii online: <https://www.materialelectrice.ro/mounting-carrier-for-3-conductor-terminal-blocks-221-series-4-mm2-with-snap-in-mounting-foot-for-horizontal-mounting-black-147566>