

Furnizor: **Sc Trivolt Distribution SRL**
Reg. com.: J23/3300/2016
CIF: RO36421140
Adresa: Strada Apusului nr 3 (primul
sens giratoriu Tehodor Pallady-
Autostrada Soarelui), Catelu, Ilfov
Banca: BRD
IBAN: RO34BRDE441SV13182234410

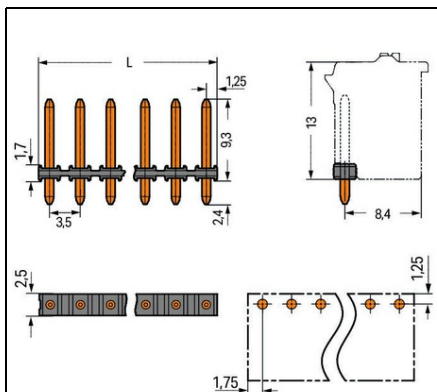

**WAGO SOLDER PIN STRIP; 1.0 MM Ø SOLDER PIN; STRAIGHT; PIN
SPACING 3.5 MM; 6-POLE; BLACK**

Ratings per: IEC/EN 60664-1;
Tensiune nominala (III/3): 160; V
Tensiune nominala de supratensiune (III/3): 2,5; kV
Tensiune nominala (III/2): 160; V
Tensiune nominala de supratensiune (III/2): 2,5; kV
Tensiune nominala (II/2): 320; V
Tensiune nominala de supratensiune (II/2): 2,5; kV
Curent nominal: 10; A
Legend (ratings): (III / 2) % Overvoltage category III / Pollution degree 2;
Certificari: UL 1059;
Numar poli: 6;
Numar tipuri de conexiuni: 1;
Numar nivele: 1;
Distanta intre pini: 3.5 mm / 0.138 inch;
Latime: 22.5 mm / 0.886 inch;
Inaltime: 11.7 mm / 0.461 inch;
Inaltime de la fata: 9.3 mm / 0.366 inch;
Adancime: 2.5 mm / 0.098 inch;
Lungimea pinului de contact: 2,4; mm
Diametrul pinului de contact: 1; mm
Diametru placat prin gaura (THR): 1.2 (+0.1) mm;
Tip contact (pluggable connector): Conector tata/fisa;
Connector (connection type): for PCBs;
Mismatching protection: No;
Mating direction to the PCB: 90; °
PCB contact: THR;
Culoare: black;
Material group: I;
Material izolator: Polyphthalamide (PPA GF);
Flammability class per UL94: V0;
Contact material: Cupru electrolytic(ESu);
Contact plating: tin-plated;
Greutate: 0,5; g
Temperatura lucru: -60 ... +100 °C;
Tip ambalare: bag;
Tara de origine: CN;
GTIN: 4055143935487;
Customs tariff number: 85369010000;
Pret: 5,20 lei (TVA inclus)

Detalii online: <https://www.materialelectrice.ro/solder-pin-strip-1-0-mm-oe-solder-pin-straight-pin-spacing-3-5-mm-6-pole-black-144464>