

Furnizor: **Sc Trivolt Distribution SRL**
Reg. com.: J23/3300/2016
CIF: RO36421140
Adresa: Strada Apusului nr 3 (primul
sens giratoriu Tehodor Pallady-
Autostrada Soarelui), Catelu, Ilfov
Banca: BRD
IBAN: RO34BRDE441SV13182234410

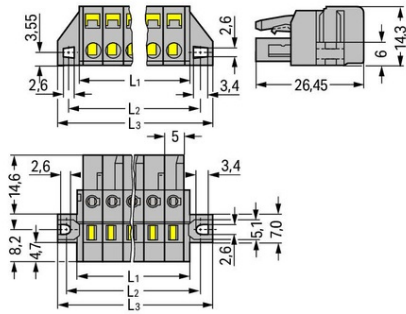

**WAGO 1-CONDUCTOR FEMALE PLUG; CLAMPING COLLAR; 2.5 MM²;
PIN SPACING 5 MM; 6-POLE; 2,50 MM²; GRAY**

Ratings per: IEC/EN 60664-1;
Tensiune nominala (III/3): 320; V
Tensiune nominala de supratensiune (III/3): 4; kV
Tensiune nominala (III/2): 320; V
Tensiune nominala de supratensiune (III/2): 4; kV
Tensiune nominala (II/2): 630; V
Tensiune nominala de supratensiune (II/2): 4; kV
Curent nominal: 16; A
Legend (ratings): (III / 2) \hat{a} %TM Overvoltage category III / Pollution degree 2;
Tensiune nominala UL (Use Group B): 300; V
Curent nominal UL (Use Group B): 15; A
Tensiune nominala UL (Use Group D): 300; V
Curent nominal UL (Use Group D): 10; A
Certificari: UL 1059;
Tensiune nominala UL 1977: 600; V
Curent nominal UL 1977: 15; A
Tensiune nominala CSA (Use Group B): 300; V
Curent nominal CSA (Use Group B): 15; A
Tensiune nominala CSA (Use Group D): 300; V
Curent nominal CSA (Use Group D): 10; A
Tehnologie conexiune: CAGE CLAMP®;
Tip actionare: Operating tool;
Solid conductor: 0.08 ... 2.5 mm² / 28 ... 12 AWG;
Fine-stranded conductor: 0.08 ... 2.5 mm² / 28 ... 12 AWG;
Fine-stranded conductor; with insulated ferrule: 0.25 ... 1.5 mm²;
Fine-stranded conductor; with uninsulated ferrule: 0.25 ... 2.5 mm²;
Strip length: 8 ... 9 mm / 0.31 ... 0.35 inch;
Numar poli: 6;
Numar total de conexiuni: 6;
Total number of potentials: 6;
Numar tipuri de conexiuni: 1;
Numar nivele: 1;
Conductor entry direction to mating direction: 0; °
Distanta intre pini: 5 mm / 0.197 inch;
Latime: 44.8 mm / 1.764 inch;
Inaltime: 14.3 mm / 0.563 inch;
Adancime: 26.45 mm / 1.041 inch;
Tip montaj: Mounting flange;
Tip montaj: Feed-through mounting; Panel mounting;
Tip contact (pluggable connector): Conector mama/priza;
Connector (connection type): for conductors;
Mismating protection: No;
Culoare: gray;
Material group: I;
Material izolator: Polyamide 66 (PA 66);
Flammability class per UL94: V0;
Clamping spring material: Chrome nickel spring steel (CrNi);
Contact material: Copper alloy;
Contact plating: tin-plated;
Fire load: 0,176; MJ
Greutate: 11,5; g
Temperatura lucru: -60 ... +85 °C;
Product Group: 3 (Multi Conn. System);
Tip ambalare: BOX;
Tara de origine: DE;
GTIN: 4044918339506;
Customs tariff number: 85366990990;
Pret: 23,82 lei (TVA inclus)

Detalii online: <https://www.materialelectrice.ro/1-conductor-female-plug-clamping-collar-2-5-mm2-pin-spacing-5-mm-6-pole-2-50-mm2-gray-143559>