

Furnizor: **Sc Trivolt Distribution SRL**  
Reg. com.: J23/3300/2016  
CIF: RO36421140  
Adresa: Strada Apusului nr 3 ( primul  
sens giratoriu Tehodor Pallady-  
Autostrada Soarelui), Catelu, Ilfov  
Banca: BRD  
IBAN: RO34BRDE441SV13182234410

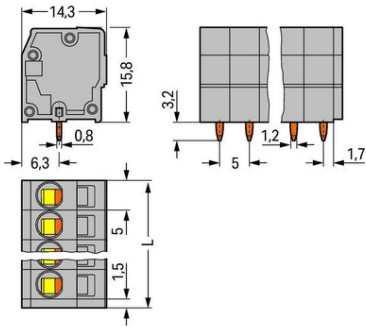

**WAGO PCB TERMINAL BLOCK; 2.5 MM<sup>2</sup>; PIN SPACING 5 MM; 15-  
POLE; CAGE CLAMP®; 2,50 MM<sup>2</sup>; GRAY**

Ratings per: IEC/EN 60664-1;  
Tensiune nominala (III/3): 320; V  
Tensiune nominala de supratensiune (III/3): 4; kV  
Tensiune nominala (III/2): 320; V  
Tensiune nominala de supratensiune (III/2): 4; kV  
Tensiune nominala (II/2): 630; V  
Tensiune nominala de supratensiune (II/2): 4; kV  
Curent nominal: 24; A  
Legend (ratings): (III / 2) %™ Overvoltage category III / Pollution degree 2;  
Tensiune nominala UL (Use Group B): 300; V  
Curent nominal UL (Use Group B): 20; A  
Tensiune nominala UL (Use Group D): 300; V  
Curent nominal UL (Use Group D): 10; A  
Certificari: UL 1059;  
Tensiune nominala CSA (Use Group B): 300; V  
Curent nominal CSA (Use Group B): 12; A  
Tensiune nominala CSA (Use Group D): 300; V  
Curent nominal CSA (Use Group D): 10; A  
Tehnologie conexiune: CAGE CLAMP®;  
Tip actionare: Operating tool;  
Solid conductor: 0,08 ... 2,5 mm<sup>2</sup> / 28 ... 14 AWG;  
Fine-stranded conductor: 0,08 ... 2,5 mm<sup>2</sup> / 28 ... 12 AWG;  
Fine-stranded conductor; with insulated ferrule: 0,25 ... 1,5 mm<sup>2</sup>;  
Fine-stranded conductor; with uninsulated ferrule: 0,25 ... 2,5 mm<sup>2</sup>;  
Strip length: 8 ... 9 mm / 0.31 ... 0.35 inch;  
Conductor connection direction to PCB: 90; °  
Numar poli: 15;  
Numar total de conexiuni: 15;  
Total number of potentials: 15;  
Numar tipuri de conexiuni: 1;  
Numar nivele: 1;  
Note (conductor cross-section): 12 AWG: THHN, THWN;  
Distanta intre pini: 5 mm / 0.197 inch;  
Latime: 76,5 mm / 3.012 inch;  
Inaltime: 19 mm / 0.748 inch;  
Inaltime de la fata: 15,8 mm / 0.622 inch;  
Adancime: 14,3 mm / 0.563 inch;  
Lungimea pinului de contact: 3,2; mm  
Solder pin dimensions: 0,8 x 1,2 mm;  
Diametrul de gaurire cu toleranta: 1,6 (+0,1) mm;  
PCB contact: THT;  
Solder pin arrangement: over the entire terminal strip (in-line);  
Number of solder pins per potential: 1;  
Culoare: gray;  
Material group: I;  
Material izolator: Polyamide 66 (PA 66);  
Flammability class per UL94: V0;  
Clamping spring material: Chrome nickel spring steel (CrNi);  
Contact material: Cupru electrolitic (ECu);  
Contact plating: tin-plated;  
Fire load: 0,293; MJ  
Greutate: 17,1; g  
Temperatura lucru: -60 ... +105 °C;  
Product Group: 4 (Printed Circuit);  
Tip ambalare: BOX;  
Tara de origine: CH;  
GTIN: 4044918859899;  
Customs tariff number: 85369010000;  
Pret: 30,21 lei (TVA inclus)

Detalii online: <https://www.materialelectrice.ro/pcb-terminal-block-2-5-mm2-pin-spacing-5-mm-15-pole-cage-clamp-2-50-mm2-gray-143438>