

Furnizor: **Sc Trivolt Distribution SRL**
Reg. com.: J23/3300/2016
CIF: RO36421140
Adresa: Strada Apusului nr 3 (primul
sens giratoriu Tehodor Pallady-
Autostrada Soarelui), Catelu, Ilfov
Banca: BRD
IBAN: RO34BRDE441SV13182234410

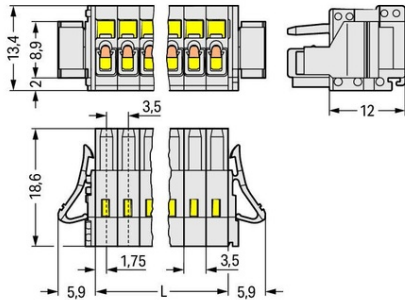

**WAGO 1-CONDUCTOR FEMALE PLUG; 100% PROTECTED AGAINST
MISMATING; LOCKING LEVER; 1.5 MM²; PIN SPACING 3.5 MM; 20-
POLE; 1.50 MM²; LIGHT GRAY**

Ratings per: IEC/EN 60664-1;
Tensiune nominala (III/3): 160; V
Tensiune nominala de supratensiune (III/3): 2,5; kV
Tensiune nominala (III/2): 160; V
Tensiune nominala de supratensiune (III/2): 2,5; kV
Tensiune nominala (II/2): 320; V
Tensiune nominala de supratensiune (II/2): 2,5; kV
Curent nominal: 10; A
Legend (ratings): (III / 2) \hat{a} %TM Overvoltage category III / Pollution degree 2;
Tensiune nominala UL (Use Group B): 300; V
Curent nominal UL (Use Group B): 10; A
Tensiune nominala UL (Use Group D): 300; V
Curent nominal UL (Use Group D): 10; A
Certificari: UL 1059;
Tensiune nominala CSA (Use Group B): 300; V
Curent nominal CSA (Use Group B): 10; A
Tensiune nominala CSA (Use Group D): 300; V
Curent nominal CSA (Use Group D): 10; A
Tehnologie conexiune: CAGE CLAMP®;
Tip actionare: Operating tool;
Solid conductor: 0,08 ... 1,5 mm² / 28 ... 14 AWG;
Fine-stranded conductor: 0,08 ... 1,5 mm² / 28 ... 14 AWG;
Fine-stranded conductor; with insulated ferrule: 0,25 ... 1,5 mm²;
Fine-stranded conductor; with uninsulated ferrule: 0,25 ... 1,5 mm²;
Strip length: 6 ... 7 mm / 0.24 ... 0.28 inch;
Numar poli: 20;
Numar total de conexiuni: 20;
Total number of potentials: 20;
Numar tipuri de conexiuni: 1;
Numar nivele: 1;
Note (conductor cross-section): Terminating 1.5 mm² conductors is possible; however insulation diameter does not allow clamping units to be terminated in a row.;
Conductor entry direction to mating direction: 0; °
Distanta intre pini: 3,5 mm / 0.138 inch;
Latime: 81,8 mm / 3.22 inch;
Inaltime: 13,4 mm / 0.528 inch;
Adancime: 18,6 mm / 0.732 inch;
Tip contact (pluggable connector): Conector mama/priza;
Connector (connection type): for conductor;
Mismating protection: Yes;
Locking of plug-in connection: locking lever;
Culoare: light gray;
Material group: I;
Material izolator: Polyamide 66 (PA 66);
Flammability class per UL94: V0;
Clamping spring material: Chrome nickel spring steel (CrNi);
Contact material: Copper alloy;
Contact plating: tin-plated;
Fire load: 0,243; MJ
Greutate: 15,5; g
Temperatura lucru: -60 ... +100 °C;
Product Group: 3 (Multi Conn. System);
Tip ambalare: BOX;
Tara de origine: DE;
GTIN: 4044918495578;
Customs tariff number: 85366990990;
Pret: 69,57 lei (TVA inclus)

Detalii online: <https://www.materialelectrice.ro/1-conductor-female-plug-100-protected-against-mismating-locking-lever-1-5-mm2-pin-spacing-3-5-mm-20-pole-1-50-mm2-light-gray-142817>