

Furnizor: **Sc Trivolt Distribution SRL**
Reg. com.: J23/3300/2016
CIF: RO36421140
Adresa: Strada Apusului nr 3 (primul
sens giratoriu Tehodor Pallady-
Autostrada Soarelui), Catelu, Ilfov
Banca: BRD
IBAN: RO34BRDE441SV13182234410

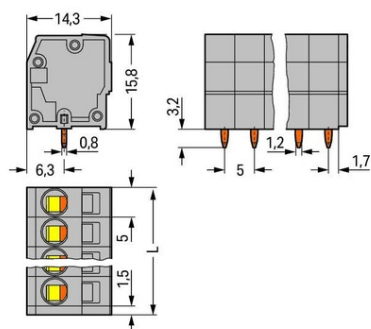

**WAGO PCB TERMINAL BLOCK; 2.5 MM²; PIN SPACING 5 MM; 7-
POLE; CAGE CLAMP®; 2,50 MM²; GRAY**

Ratings per: IEC/EN 60664-1;
Tensiune nominala (III/3): 320; V
Tensiune nominala de supratensiune (III/3): 4; kV
Tensiune nominala (III/2): 320; V
Tensiune nominala de supratensiune (III/2): 4; kV
Tensiune nominala (II/2): 630; V
Tensiune nominala de supratensiune (II/2): 4; kV
Curent nominal: 24; A
Legend (ratings): (III / 2) %™ Overvoltage category III / Pollution degree 2;
Tensiune nominala UL (Use Group B): 300; V
Curent nominal UL (Use Group B): 20; A
Tensiune nominala UL (Use Group D): 300; V
Curent nominal UL (Use Group D): 10; A
Certificari: UL 1059;
Tensiune nominala CSA (Use Group B): 300; V
Curent nominal CSA (Use Group B): 12; A
Tensiune nominala CSA (Use Group D): 300; V
Curent nominal CSA (Use Group D): 10; A
Tehnologie conexiune: CAGE CLAMP®;
Tip actionare: Operating tool;
Solid conductor: 0,08 ... 2,5 mm² / 28 ... 14 AWG;
Fine-stranded conductor: 0,08 ... 2,5 mm² / 28 ... 12 AWG;
Fine-stranded conductor; with insulated ferrule: 0,25 ... 1,5 mm²;
Fine-stranded conductor; with uninsulated ferrule: 0,25 ... 2,5 mm²;
Strip length: 8 ... 9 mm / 0.31 ... 0.35 inch;
Conductor connection direction to PCB: 90; °
Numar poli: 7;
Numar total de conexiuni: 7;
Total number of potentials: 7;
Numar tipuri de conexiuni: 1;
Numar nivele: 1;
Note (conductor cross-section): 12 AWG: THHN, THWN;
Distanta intre pini: 5 mm / 0.197 inch;
Latime: 36,5 mm / 1.437 inch;
Inaltime: 19 mm / 0.748 inch;
Inaltime de la fata: 15,8 mm / 0.622 inch;
Adancime: 14,3 mm / 0.563 inch;
Lungimea pinului de contact: 3,2; mm
Solder pin dimensions: 0,8 x 1,2 mm;
Diametrul de gaurire cu toleranta: 1,6 (+0,1) mm;
PCB contact: THT;
Solder pin arrangement: over the entire terminal strip (in-line);
Number of solder pins per potential: 1;
Culoare: gray;
Material group: I;
Material izolator: Polyamide 66 (PA 66);
Flammability class per UL94: V0;
Clamping spring material: Chrome nickel spring steel (CrNi);
Contact material: Cupru electrolitic (ECu);
Contact plating: tin-plated;
Fire load: 0,141; MJ
Greutate: 8,1; g
Temperatura lucru: -60 ... +105 °C;
Product Group: 4 (Printed Circuit);
Tip ambalare: BOX;
Tara de origine: CH;
GTIN: 4044918859653;
Customs tariff number: 85369010000;
Pret: 14,44 lei (TVA inclus)

Detalii online: <https://www.materialelectrice.ro/pcb-terminal-block-2-5-mm2-pin-spacing-5-mm-7-pole-cage-clamp-2-50-mm2-gray-142439>