

Furnizor: **Sc Trivolt Distribution SRL**
 Reg. com.: J23/3300/2016
 CIF: RO36421140
 Adresa: Strada Apusului nr 3 (primul
 sens giratoriu Tehodor Pallady-
 Autostrada Soarelui), Catelu, Ilfov
 Banca: BRD
 IBAN: RO34BRDE441SV13182234410

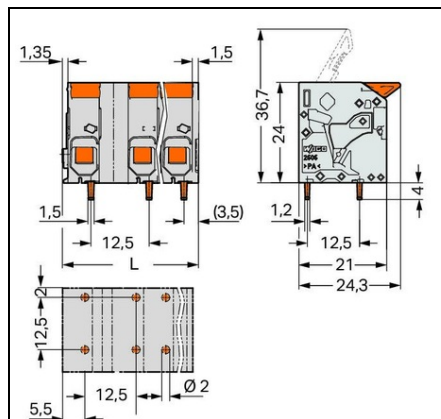

WAGO PCB TERMINAL BLOCK; LEVER; 6 MM²; PIN SPACING 12.5 MM; 10-POLE; PUSH-IN CAGE CLAMP®; 6.00 MM²; GRAY

Ratings per: IEC/EN 60664-1;
 Tensiune nominala (III/3): 800; V
 Tensiune nominala de supratensiune (III/3): 8; kV
 Tensiune nominala (III/2): 1000; V
 Tensiune nominala de supratensiune (III/2): 8; kV
 Tensiune nominala (II/2): 1000; V
 Tensiune nominala de supratensiune (II/2): 8; kV
 Curent nominal: 41; A
 Legend (ratings): (III / 2) \hat{a} %TM Overvoltage category III / Pollution degree 2;
 Tensiune nominala UL (Use Group B): 600; V
 Curent nominal UL (Use Group B): 42; A
 Tensiune nominala UL (Use Group C): 600; V
 Curent nominal UL (Use Group C): 42; A
 Certificari: UL 1059;
 Tehnologie conexiune: Push-in CAGE CLAMP®;
 Tip actionare: Lever;
 Solid conductor: 0,2 ... 10 mm² / 24 ... 8 AWG;
 Fine-stranded conductor: 0,2 ... 10 mm² / 24 ... 8 AWG;
 Fine-stranded conductor; with insulated ferrule: 0,25 ... 6 mm²;
 Fine-stranded conductor; with uninsulated ferrule: 0,25 ... 6 mm²;
 Fine-stranded conductor; with twin ferrule: 0,25 ... 2,5 mm²;
 Strip length: 11 ... 13 mm / 0.43 ... 0.51 inch;
 Conductor connection direction to PCB: 0; °
 Numar poli: 10;
 Numar total de conexiuni: 10;
 Total number of potentials: 10;
 Numar tipuri de conexiuni: 1;
 Numar nivele: 1;
 Distanta intre pini: 12,5 mm / 0.492 inch;
 Latime: 121,5 mm / 4.783 inch;
 Inaltime: 28 mm / 1.102 inch;
 Inaltime de la fata: 24 mm / 0.945 inch;
 Lungimea pinului de contact: 4; mm
 Solder pin dimensions: 1,5 x 1,2 mm;
 Diametrul de gaurire cu toleranta: 2 (+0,1) mm;
 PCB contact: THT;
 Solder pin arrangement: over the entire terminal strip (in-line);
 Number of solder pins per potential: 2;
 Culoare: gray;
 Material group: I;
 Material izolator: Polyamide 66 (PA 66);
 Flammability class per UL94: V0;
 Clamping spring material: Chrome nickel spring steel (CrNi);
 Contact material: Cupru electrolitic (ECu);
 Contact plating: tin-plated;
 Color of actuator: orange;
 Greutate: 53,2; g
 Temperatura lucru: -60 ... +105 °C;
 Tip ambalare: BOX;
 Tara de origine: DE;
 GTIN: 4055143862226;
 Customs tariff number: 85369010000;
 Pret: 93,20 lei (TVA inclus)

Detalii online: <https://www.materialelectrice.ro/pcb-terminal-block-lever-6-mm2-pin-spacing-12-5-mm-10-pole-push-in-cage-clamp-6-00-mm2-gray-136193>