

Furnizor: **Sc Trivolt Distribution SRL**
Reg. com.: J23/3300/2016
CIF: RO36421140
Adresa: Strada Apusului nr 3 (primul
sens giratoriu Tehodor Pallady-
Autostrada Soarelui), Catelu, Ilfov
Banca: BRD
IBAN: RO34BRDE441SV13182234410

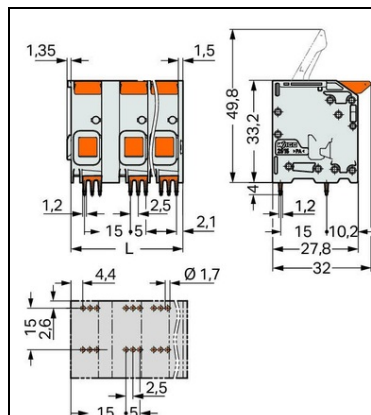

WAGO PCB TERMINAL BLOCK; LEVER; 16 MM²; PIN SPACING 15 MM; 6-POLE; PUSH-IN CAGE CLAMP®; 16,00 MM²; GRAY

Ratings per: IEC/EN 60664-1;
Tensiune nominala (III/3): 800; V
Tensiune nominala de supratensiune (III/3): 8; kV
Tensiune nominala (III/2): 1000; V
Tensiune nominala de supratensiune (III/2): 8; kV
Tensiune nominala (II/2): 1000; V
Tensiune nominala de supratensiune (II/2): 8; kV
Curent nominal: 76; A
Legend (ratings): (III / 2) \hat{a} %TM Overvoltage category III / Pollution degree 2;
Tensiune nominala UL (Use Group B): 300; V
Curent nominal UL (Use Group B): 78; A
Tensiune nominala UL (Use Group C): 300; V
Curent nominal UL (Use Group C): 78; A
Certificari: UL 1059;
Tehnologie conexiune: Push-in CAGE CLAMP®;
Tip actionare: Lever;
Solid conductor: 0,75 ... 16 mm² / 18 ... 4 AWG;
Fine-stranded conductor: 0,75 ... 25 mm² / 18 ... 4 AWG;
Fine-stranded conductor; with insulated ferrule: 0,75 ... 16 mm²;
Fine-stranded conductor; with uninsulated ferrule: 0,75 ... 16 mm²;
Fine-stranded conductor; with twin ferrule: 0,75 ... 6 mm²;
Strip length: 18 ... 20 mm / 0.71 ... 0.79 inch;
Conductor connection direction to PCB: 0; °
Numar poli: 6;
Numar tipuri de conexiuni: 1;
Numar nivele: 1;
Distanta intre pini: 15 mm / 0.591 inch;
Latime: 86,5 mm / 3.406 inch;
Inaltime: 37,2 mm / 1.465 inch;
Inaltime de la fata: 33,2 mm / 1.307 inch;
Adancime: 32 mm / 1.26 inch;
Lungimea pinului de contact: 4; mm
Solder pin dimensions: 1,2 x 1,2 mm;
Diametrul de gaurire cu toleranta: 1,7 (+0,1) mm;
PCB contact: THT;
Solder pin arrangement: over the entire female connector (in-line);
Number of solder pins per potential: 6;
Culoare: gray;
Material group: I;
Material izolator: Polyamide 66 (PA 66);
Flammability class per UL94: V0;
Clamping spring material: Chrome nickel spring steel (CrNi);
Contact material: Cupru electrolitic(ECu);
Contact plating: tin-plated;
Color of actuator: orange;
Greutate: 68,2; g
Temperatura lucru: -60 ... +105 °C;
Tip ambalare: BOX;
Tara de origine: DE;
GTIN: 4055143860420;
Customs tariff number: 85369010000;
Pret: 101,46 lei (TVA inclus)

Detalii online: <https://www.materialelectrice.ro/pcb-terminal-block-lever-16-mm2-pin-spacing-15-mm-6-pole-push-in-cage-clamp-16-00-mm2-gray-136041>