

Furnizor: **Sc Trivolt Distribution SRL**  
Reg. com.: J23/3300/2016  
CIF: RO36421140  
Adresa: Strada Apusului nr 3 ( primul  
sens giratoriu Tehodor Pallady-  
Autostrada Soarelui), Catelu, Ilfov  
Banca: BRD  
IBAN: RO34BRDE441SV13182234410

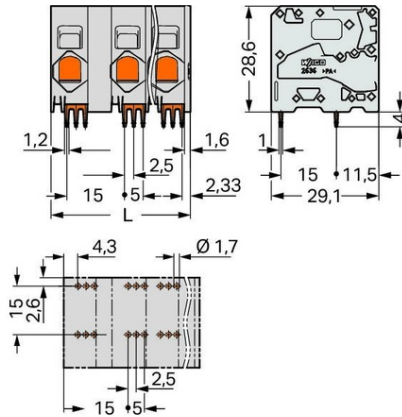

**WAGO PCB TERMINAL BLOCK; 16 MM<sup>2</sup>; PIN SPACING 15 MM; 2-  
POLE; PUSH-IN CAGE CLAMP®; 16,00 MM<sup>2</sup>; GRAY**

Ratings per: IEC/EN 60664-1;  
Tensiune nominala (III/3): 1000; V  
Tensiune nominala de supratensiune (III/3): 8; kV  
Tensiune nominala (III/2): 1000; V  
Tensiune nominala de supratensiune (III/2): 8; kV  
Tensiune nominala (II/2): 1000; V  
Tensiune nominala de supratensiune (II/2): 8; kV  
Curent nominal: 76; A  
Legend (ratings): (III / 2)  $\hat{a}$ %™ Overvoltage category III / Pollution degree 2;  
Tensiune nominala UL (Use Group B): 300; V  
Curent nominal UL (Use Group B): 85; A  
Tensiune nominala UL (Use Group C): 300; V  
Curent nominal UL (Use Group C): 85; A  
Certificari: UL 1059;  
Tehnologie conexiune: Push-in CAGE CLAMP®;  
Tip actionare: Operating tool;  
Solid conductor: 0,75 ... 16 mm<sup>2</sup> / 18 ... 4 AWG;  
Fine-stranded conductor: 0,75 ... 25 mm<sup>2</sup> / 18 ... 4 AWG;  
Fine-stranded conductor; with insulated ferrule: 0,75 ... 16 mm<sup>2</sup>;  
Fine-stranded conductor; with uninsulated ferrule: 0,75 ... 16 mm<sup>2</sup>;  
Fine-stranded conductor; with twin ferrule: 0,75 ... 6 mm<sup>2</sup>;  
Strip length: 18 ... 20 mm / 0.71 ... 0.79 inch;  
Conductor connection direction to PCB: 0; °  
Numar poli: 2;  
Numar total de conexiuni: 2;  
Total number of potentials: 2;  
Numar tipuri de conexiuni: 1;  
Numar nivele: 1;  
Distanta intre pini: 15 mm / 0.591 inch;  
Latime: 26,6 mm / 1.047 inch;  
Inaltime: 32,6 mm / 1.283 inch;  
Inaltime de la fata: 28,6 mm / 1.126 inch;  
Adancime: 29,1 mm / 1.146 inch;  
Lungimea pinului de contact: 4; mm  
Solder pin dimensions: 1,2 x 1 mm;  
Diametrul de gaurire cu toleranta: 1,7 (+0,1) mm;  
Tip montaj: Feed-through mounting;  
PCB contact: THT;  
Solder pin arrangement: over the entire terminal strip (in-line);  
Number of solder pins per potential: 6;  
Culoare: gray;  
Material group: I;  
Material izolator: Polyamide 66 (PA 66);  
Flammability class per UL94: V0;  
Clamping spring material: Chrome nickel spring steel (CrNi);  
Contact material: Cupru electrolitic (ECu);  
Contact plating: tin-plated;  
Greutate: 19,5; g  
Temperatura lucru: -60 ... +105 °C;  
Tip ambalare: BOX;  
Tara de origine: DE;  
GTIN: 4055143861298;  
Customs tariff number: 85369010000;  
Pret: 31,06 lei (TVA inclus)

Detalii online: <https://www.materialelectrice.ro/pcb-terminal-block-16-mm2-pin-spacing-15-mm-2-pole-push-in-cage-clamp-16-00-mm2-gray-135818>