

Furnizor: **Sc Trivolt Distribution SRL**
Reg. com.: J23/3300/2016
CIF: RO36421140
Adresa: Strada Apusului nr 3 (primul
sens giratoriu Tehodor Pallady-
Autostrada Soarelui), Catelu, Ilfov
Banca: BRD
IBAN: RO34BRDE441SV13182234410

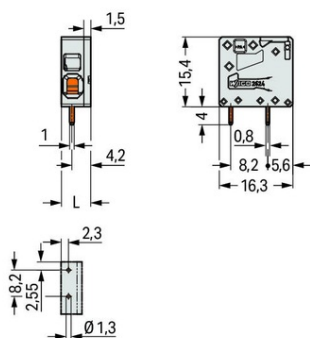

**WAGO PCB TERMINAL BLOCK; 4 MM²; PIN SPACING 5 MM; 1-POLE;
PUSH-IN CAGE CLAMP®; 4,00 MM²; GRAY**

Ratings per: IEC/EN 60664-1;
Tensiune nominala (III/3): 320; V
Tensiune nominala de supratensiune (III/3): 4; kV
Tensiune nominala (III/2): 400; V
Tensiune nominala de supratensiune (III/2): 4; kV
Tensiune nominala (II/2): 630; V
Tensiune nominala de supratensiune (II/2): 4; kV
Curent nominal: 41; A
Legend (ratings): (III / 2) \hat{a} %™ Overvoltage category III / Pollution degree 2;
Tensiune nominala UL (Use Group B): 300; V
Curent nominal UL (Use Group B): 26; A
Tensiune nominala UL (Use Group D): 300; V
Curent nominal UL (Use Group D): 10; A
Certificari: UL 1059;
Tehnologie conexiune: Push-in CAGE CLAMP®;
Tip actionare: Operating tool;
Solid conductor: 0,2 ... 6 mm² / 24 ... 10 AWG;
Fine-stranded conductor: 0,2 ... 6 mm² / 24 ... 10 AWG;
Fine-stranded conductor; with insulated ferrule: 0,25 ... 2,5 mm²;
Fine-stranded conductor; with uninsulated ferrule: 0,25 ... 2,5 mm²;
Fine-stranded conductor; with twin ferrule: 0,25 ... 1,5 mm²;
Strip length: 10 ... 12 mm / 0.39 ... 0.47 inch;
Conductor connection direction to PCB: 0; °
Numar poli: 1;
Numar total de conexiuni: 1;
Total number of potentials: 1;
Numar tipuri de conexiuni: 1;
Numar nivele: 1;
Distanta intre pini: 5 mm / 0.197 inch;
Latime: 6,5 mm / 0.256 inch;
Inaltime: 19,4 mm / 0.764 inch;
Inaltime de la fata: 15,4 mm / 0.606 inch;
Adancime: 16,3 mm / 0.642 inch;
Lungimea pinului de contact: 4; mm
Solder pin dimensions: 0,8 x 1 mm;
Diametrul de gaurire cu toleranta: 1,3 (+0,1) mm;
Tip montaj: Feed-through mounting;
PCB contact: THT;
Solder pin arrangement: within the terminal block (in-line);
Number of solder pins per potential: 2;
Culoare: gray;
Material group: I;
Material izolator: Polyamide 66 (PA 66);
Flammability class per UL94: V0;
Clamping spring material: Chrome nickel spring steel (CrNi);
Contact material: Cupru electrolitic (ECu);
Contact plating: tin-plated;
Greutate: 1,9; g
Temperatura lucru: -60 ... +105 °C;
Tip ambalare: BOX;
Tara de origine: DE;
GTIN: 4055143578295;
Customs tariff number: 85369010000;
Pret: 3,76 lei (TVA inclus)

Detalii online: <https://www.materialelectrice.ro/pcb-terminal-block-4-mm2-pin-spacing-5-mm-1-pole-push-in-cage-clamp-4-00-mm2-gray-133143>