

Furnizor: **Sc Trivolt Distribution SRL**
Reg. com.: J23/3300/2016
CIF: RO36421140
Adresa: Strada Apusului nr 3 (primul
sens giratoriu Tehodor Pallady-
Autostrada Soarelui), Catelu, Ilfov
Banca: BRD
IBAN: RO34BRDE441SV13182234410

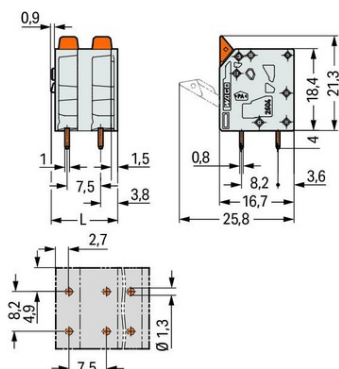

WAGO PCB TERMINAL BLOCK; LEVER; 4 MM²; PIN SPACING 7.5 MM; 10-POLE; PUSH-IN CAGE CLAMP®; 4.00 MM²; GRAY

Ratings per: IEC/EN 60664-1;
Tensiune nominala (III/3): 630; V
Tensiune nominala de supratensiune (III/3): 6; kV
Tensiune nominala (III/2): 630; V
Tensiune nominala de supratensiune (III/2): 6; kV
Tensiune nominala (II/2): 1000; V
Tensiune nominala de supratensiune (II/2): 6; kV
Curent nominal: 32; A
Legend (ratings): (III / 2) %™ Overvoltage category III / Pollution degree 2;
Tensiune nominala UL (Use Group B): 300; V
Curent nominal UL (Use Group B): 20; A
Tensiune nominala UL (Use Group C): 300; V
Curent nominal UL (Use Group C): 20; A
Tensiune nominala UL (Use Group D): 600; V
Curent nominal UL (Use Group D): 5; A
Certificari: UL 1059;
Tehnologie conexiune: Push-in CAGE CLAMP®;
Tip actionare: Lever;
Solid conductor: 0,2 ... 4 mm² / 24 ... 12 AWG;
Fine-stranded conductor: 0,2 ... 4 mm² / 24 ... 12 AWG;
Fine-stranded conductor; with insulated ferrule: 0,25 ... 2,5 mm²;
Fine-stranded conductor; with uninsulated ferrule: 0,25 ... 2,5 mm²;
Fine-stranded conductor; with twin ferrule: 0,25 ... 1,5 mm²;
Strip length: 9 ... 11 mm / 0.35 ... 0.43 inch;
Conductor connection direction to PCB: 90; °
Numar poli: 10;
Numar total de conexiuni: 10;
Total number of potentials: 10;
Numar tipuri de conexiuni: 1;
Numar nivele: 1;
Distanta intre pini: 7,5 mm / 0.295 inch;
Latime: 74,9 mm / 2.949 inch;
Inaltime: 25,3 mm / 0.996 inch;
Inaltime de la fata: 21,3 mm / 0.839 inch;
Adancime: 16,7 mm / 0.657 inch;
Lungimea pinului de contact: 4; mm
Solder pin dimensions: 0,8 x 1 mm;
Diametrul de gaurire cu toleranta: 1,3 (+0,1) mm;
PCB contact: THT;
Solder pin arrangement: over the entire terminal strip (in-line);
Number of solder pins per potential: 2;
Culoare: gray;
Material group: I;
Material izolator: Polyamide 66 (PA 66);
Flammability class per UL94: V0;
Clamping spring material: Chrome nickel spring steel (CrNi);
Contact material: Cupru electrolitic(ECu);
Contact plating: tin-plated;
Color of actuator: orange;
Greutate: 20; g
Temperatura lucru: -60 ... +105 °C;
Tip ambalare: BOX;
Tara de origine: DE;
GTIN: 4055143564946;
Customs tariff number: 85369010000;
Pret: 45,56 lei (TVA inclus)

Detalii online: <https://www.materialelectrice.ro/pcb-terminal-block-lever-4-mm2-pin-spacing-7-5-mm-10-pole-push-in-cage-clamp-4-00-mm2-gray-132034>