

Furnizor: **Sc Trivolt Distribution SRL**  
Reg. com.: J23/3300/2016  
CIF: RO36421140  
Adresa: Strada Apusului nr 3 ( primul  
sens giratoriu Tehodor Pallady-  
Autostrada Soarelui), Catelu, Ilfov  
Banca: BRD  
IBAN: RO34BRDE441SV13182234410

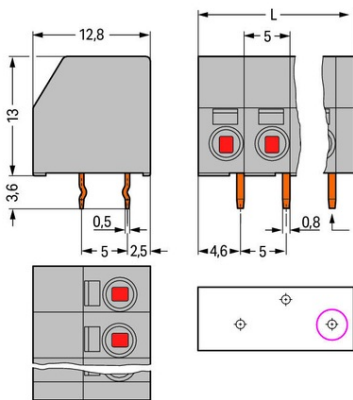

**WAGO 2-CONDUCTOR PCB TERMINAL BLOCK; 1.5 MM<sup>2</sup>; PIN  
SPACING 5 MM; 10-POLE; PUSH WIRE<sup>®</sup>; 1,50 MM<sup>2</sup>; GRAY**

Ratings per: IEC/EN 60664-1;  
Tensiune nominala (III/3): 320; V  
Tensiune nominala de supratensiune (III/3): 4; kV  
Tensiune nominala (III/2): 320; V  
Tensiune nominala de supratensiune (III/2): 4; kV  
Tensiune nominala (II/2): 630; V  
Tensiune nominala de supratensiune (II/2): 4; kV  
Curent nominal: 17,5; A  
Legend (ratings): (III / 2)  $\hat{a}$ %<sup>TM</sup> Overvoltage category III / Pollution degree 2;  
Tensiune nominala UL (Use Group B): 300; V  
Curent nominal UL (Use Group B): 8; A  
Tensiune nominala UL (Use Group D): 300; V  
Curent nominal UL (Use Group D): 8; A  
Certificari: UL 1059;  
Tensiune nominala CSA (Use Group B): 300; V  
Curent nominal CSA (Use Group B): 8; A  
Tensiune nominala CSA (Use Group D): 300; V  
Curent nominal CSA (Use Group D): 8; A  
Connection type (1): PUSH WIRE<sup>®</sup> connection;  
Tehnologie conexiune: PUSH WIRE<sup>®</sup>;  
Number of connection points (connection type): 1;  
Tip actionare: Operating tool;  
Solid conductor: 0,5 ... 1,5 mm<sup>2</sup> / 20 ... 16 AWG;  
Strip length: 8,5 ... 9,5 mm / 0.33 ... 0.37 inch;  
Note (strip length): 7 ... 8 mm / 0.28 ... 0.31 inch (for wiring on both sides);  
Conductor connection direction to PCB: 0; °  
Numar poli: 10;  
Connection type 2: PUSH WIRE<sup>®</sup> connection;  
Tehnologie conexiune 2: PUSH WIRE<sup>®</sup>;  
Number of connection points: 1;  
Solid conductor 2: 0,5 ... 1,5 mm<sup>2</sup> / 20 ... 16 AWG;  
Strip length 2: 8,5 ... 9,5 mm / 0.33 ... 0.37 inch;  
Note (strip length) 2: 7 ... 8 mm / 0.28 ... 0.31 inch (for wiring on both sides);  
Conductor connection direction to PCB 2: 90; °  
Numar total de conexiuni: 20;  
Total number of potentials: 10;  
Numar tipuri de conexiuni: 2;  
Numar nivele: 2;  
Distanta intre pini: 5 mm / 0.197 inch;  
Latime: 52 mm / 2.047 inch;  
Inaltime: 16,6 mm / 0.654 inch;  
Inaltime de la fata: 13 mm / 0.512 inch;  
Adancime: 12,8 mm / 0.504 inch;  
Lungimea pinului de contact: 3,6; mm  
Solder pin dimensions: 0,5 x 0,8 mm;  
Diametrul de gaurire cu toleranta: 1,1 (+0,1) mm;  
PCB contact: THT;  
Solder pin arrangement: over the entire terminal strip (staggered);  
Number of solder pins per potential: 1;  
Culoare: gray;  
Material group: I;  
Material izolator: Polyamide 66 (PA 66);  
Flammability class per UL94: V0;  
Clamping spring material: Chrome nickel spring steel (CrNi);  
Contact material: Cupru electrolitic (ECu);  
Contact plating: tin-plated;  
Fire load: 0,18; MJ  
Greutate: 8,7; g  
Temperatura lucru: -60 ... +105 °C;  
Product Group: 4 (Printed Circuit);  
Tip ambalare: BOX;  
Tara de origine: CN;  
GTIN: 4044918689588;  
Customs tariff number: 85369010000;  
Pret: 13,67 lei (TVA inclus)

Detalii online: <https://www.materialelectrice.ro/2-conductor-pcb-terminal-block-1-5-mm2-pin-spacing-5-mm-10-pole-push-wire-1-50-mm2-gray-131301>